



---

**FVA Trogflux** variable area flowmeter

# Operating Instructions

All rights reserved. It is prohibited to reproduce this document, or any parts thereof, without prior written authorization of MECON Flow Control Systems GmbH.

Subject to change without notice.

Copyright 2014 by  
MECON Flow Control Systems GmbH - Röntgenstraße 105 - 50169 Kerpen

# Contents

<b>1 Safety Instructions</b>	<b>4</b>
1.1 Intended use	4
1.2 Certifications	5
1.3 Safety instructions from the manufacturer	5
<b>2 Start-up</b>	<b>6</b>
2.1 Standard device	6
<b>3 Installation</b>	<b>7</b>
3.1 Installation instructions	7
3.2 Installation	7
<b>4 Service</b>	<b>8</b>
4.1 Storage	8
4.2 Maintenance	8
4.3 Returning the device to the manufacturer	8
<b>5 Device Description</b>	<b>9</b>
5.1 Scope of delivery	9
5.2 Versions	9
5.3 Nameplate	10
<b>6 Description Code</b>	<b>11</b>
<b>7 Measuring range liquids</b>	<b>13</b>
<b>8 Measuring range air</b>	<b>14</b>
<b>9 Technical data</b>	<b>14</b>
9.1 Pressure und temperature limits	15
9.2 Dimensions	16
9.3 Float selection	16
<b>10 Contacts</b>	<b>17</b>

# 1 Safety Instructions

## 1.1 Intended use

The FVA Troglux variable area meters are used to measure the volume of transparent liquids and gases into closed piping. The variable area meters can also be used for flow monitoring if they are equipped with one or more switching contacts. Standard scales are available for liquids with a density of 1 kg/l (62.43 lb/cu.ft). The scales must be recalculated for all other media depending on the physical characteristics.

**The devices are particularly suitable for the measurement of:**

- Water
- Clear liquids
- Gas flows



**Warning !**

*The operator of these measuring devices is solely responsible for the suitability, intended use and corrosion resistance of the selected materials. It must be particularly ensured that the materials selected for the wetted parts of the flowmeter are suitable for the process media to be measured.*

*The manufacturer is not liable for any damage resulting from improper or unintended use of these devices.*

No external loads may act upon the meter. The flowmeters are primarily designed for static applications.



**Caution!**

*Hot surfaces resulting from hot process media.*

*Danger of burns resulting from surface temperatures above 70 °C.*

- *Take appropriate protective measures, for example contact protection.*
- *The design of the contact protection must meet the maximum permissible ambient temperature of the meter.*

The flowmeter may only be operated within the pressure and voltage limits specified on the name plate.

Before taking the flowmeter out of operations, check that the unit is free of hazardous media and de-pressurized.

## 1.2 Certifications

### CE marking



**The manufacturer certifies that the device FVA Trogflux meets all statutory requirements of the following EC directives by applying the CE marking:**

- Pressure equipment directive 97/23/EC

**The most hazardous permissible media are**

- **for gases: fluids of group 2**
- **for liquids: fluids of group 1.**

## 1.3 Safety instructions from the manufacturer

### Disclaimer

The manufacturer will not be liable for any damage resulting from the use of its product, including, but not limited to direct, indirect, incidental, punitive and consequential damages.

Any product purchased from the manufacturer is warranted in accordance with the relevant product documentation and our Terms and Conditions of Sale.

The manufacturer reserves the right to revise the content of its documents, including this disclaimer, without prior notification, and will not be liable in any way for possible consequences of such changes.

### Product liability and warranty

Mecon GmbH assumes no guarantee for repair work carried out by the customer without prior notification and consultation. Any instruments or parts rejected by a customer must be returned to us, if no other arrangement has been made.

### General information

This manual is intended for the correct installation as well as operation and maintenance of the devices. Read the instructions carefully before installing the device and placing it into operation.

Specially designed or customised models and specialised applications are not included in this manual.

## 2 Start-up

### 2.1 Standard device

**When starting up the unit, the following points must be observed:**

- Make sure that the actual operating conditions (pressure and temperature) do not exceed the limits specified on the nameplate.
- **Avoid float impact!**  
Therefore it is recommended to start with a closed shut-off valve during commissioning and adjust the operating pressure by opening the valve slowly.  
In particular, the use of magnetic valves is not recommended in this case.
- When measuring liquids, make a careful release of the pipeline to prevent pressure peaks by gas bubbles.
- When commissioning new devices increasingly residues can stick on the float. Therefore we recommend to clean the equipment after a relatively short time.
- When using the devices in the lower measuring range the device must be operated at a higher flow rate for a short time to enable settling of the float.

**Exceptions for the measurements of gases:**

- Provide valves downstream the flowmeter if  $p_{abs} > 1,013$  bar and usually upstream the flowmeter if  $p_{abs} = 1,013$  bar (no overpressure).
- Install a flow control valve close to the flowmeter (downstream), to prevent oscillations during the measurement.
- Adjust the operating pressure exactly to the reference pressure (during calibration) to prevent measurement errors.

## 3 Installation

### 3.1 Installation instructions

**Information !**

*All instruments are carefully checked for proper function before shipment. Check immediately on receipt, the outer packing carefully for damage or signs of improper handling.*

*Report damage to the carrier and your competent sales staff. In such cases, a description of the defect, the type and the serial number of the device is indicated.*

**Information !**

*Unpack the unit carefully to avoid damage.*

**Information !**

*Check the completeness of the delivery by using the packing list. Check the name plate, if the delivered flow meter is according to your order. Especially check units with electrical components for the correct supply voltage.*

### 3.2 Installation

For specific device sizes the float is inserted with a plastic net for transport lock. This must be removed through the top of the meter before installation. After that the free movement of the float inside the flow tube should be checked again.

The device must be mounted vertically and stress-free. Reductions, extensions, and control elements upstream and downstream of the meter have no influence on the measurement accuracy with liquids. For gases, however, the installation of the meter is recommended before valves to prevent compression oscillations.

Since variable area flow meters are very sensitive to changes in flow, control elements should always be adjusted slowly. The calibration is carried out for defined conditions. It is essential to ensure compliance with the calibration conditions. Deviations of the density, pressure or temperature of gases, as well as density and viscosity of liquids, result in errors. Therefore it is essential to specify the following data of the medium in the order: the medium, the density and the viscosity at operating temperature and pressure. For gases, the exact reference point for the pressure (gauge or absolute pressure) is also required.

Retrofitting of switching contacts is only possible when the floats are equipped with magnets. When commissioning the contact we recommend to ensure the correct position of the bistable contact by moving the float along the contact in flow direction.

## 4 Service

### 4.1 Storage

Store the device dry and dust free.

Avoid direct exposure to the sun and heat.

Avoid external loads on the device.

The admissible storage temperature for standard devices with electrical components: -40 ... +70 °C.

### 4.2 Maintenance

The devices are built for low maintenance operations but periodically the flowmeters should be inspected for signs of corrosion, mechanical wear as well as damage to the fitting and the display unit.

We advice to carry out inspections at least once a year.

For a detailed inspection and cleaning the device must be removed from the piping.



**Caution !**

*Appropriate safety precautions have to be taken when removing the device. Always use new gaskets when reinstalling the device in the piping..*

### 4.3 Returning the device to the manufacturer

This device has been carefully manufactured and tested.

Should you nevertheless need to return a device to MECON GmbH please observe the following points:



**Caution !**

*According to the actual waste disposal directives, the owner/customer is responsible for the waste management of hazardous and toxic waste.*

*For reasons of environmental protection and safeguarding the health and safety of our personnel **all devices sent to MECON GmbH to be repaired must be free of toxic and hazardous substances. This also applies to cavities of the devices. If necessary the customer is kindly requested to neutralize or rinse the devices before returning them to MECON.***

*The customer has to confirm this by filling in an appropriate form which is available for download on the MECON website:*

[www.meccon.de/en/Declaration/Decontamination.pdf](http://www.meccon.de/en/Declaration/Decontamination.pdf)



**Caution !**

*In case of returning devices which contain hazardous and toxic substances MECON GmbH is entitled to dispose of these substances at cost to the customer without any further notices*



## 5 Device Description

### 5.1 Scope of delivery



**Fig. 1** Scope of delivery



**Information !**

**Please check the delivery for completeness using the packing list.**

### 5.2 Versions



**Fig. 2** Standard device with PVC adhesive bushing



**Fig. 3** Standard device with female thread

The main components of the FVA Troglux are the measuring tube made of plastics, the float and the connecting parts. A scale is printed on the flow tube (eg in l / h). The actual flowrate is read at

the position of the largest diameter of the float. For process monitoring and control, the unit can be equipped with one or more contacts.

### Special features

- Product scales for liquids and gases
- Easy to install
- Low cost plastic version
- Short delivery times for standard versions

## 5.3 Nameplate



### **Important !**

**Please refer to the device nameplate to ensure that the device is built according to your order.**

*Check particularly for the correct supply voltage.*

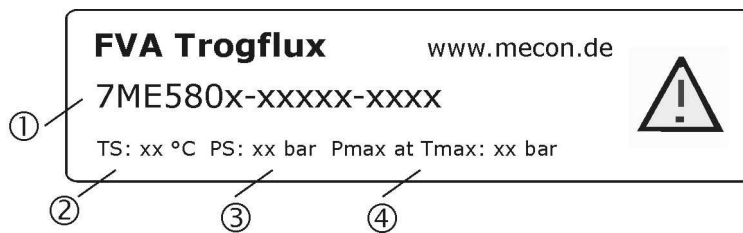

**Fig. 4** Nameplate of the FVA Trogflux

- |   |                          |  |
|---|--------------------------|--|
| ① | Code number              | Device specific code number                              |
| ② | TS Medium                | Maximum temperature of the medium                        |
| ③ | PS                       | Maximum pressure of the medium                           |
| ④ | $P_{\max}$ at $T_{\max}$ | Maximum pressure of the medium at temperature $T_{\max}$ |

## 6 Description Code

The description code consists of the following elements:

**7ME580**  -     -     / ...

①
②
③
④
⑤
⑥
⑦
⑧
⑨
⑩

### ① Plastic material for measuring cone

- 1** Trogamid
- 6** Polysulfon

### ② Gasket material

- 1** Perbunan
- 4** Viton
- 8** EPDM

### ③ Measuring cone size

- AC** 125
- BC** 315
- CD** 650
- DD** 1000
- ED** 1600
- FD** 2500
- GE** 4000
- HE** 6500
- JE** 10000
- KE** 16000
- LE** 20000
- ME** 25000

### ④ Float material

- 1** Stainless steel (Mat.-No. 1.4305)
- 2** Stainless steel (Mat.-No. 1.4571/1.4404)
- 3** PVC, weighted
- 4** Stainless steel Mat.-No. 1.4571/SV/316Ti
- 5** Aluminium
- 6** PVC, not weighted
- 7** PVDF, not weighted
- 8** PVDF, weighted

**⑤ Connection material**

- 1** PVC / Standard, for plastic tubes only
- 2** Cast iron (only for G½, G1 , G2)
- 3** Steel (not for G½, G1, G2)
- 4** Stainless steel

**⑥ Connection form**

- 1** Adhesive bushing (only made of PVC)
- 2** Female thread DIN ISO 228
- 3** Female thread NPT (NPT ANSI B1.20.1)

**⑦ Connection size**

- A** Adhesive bushing
- B** Female thread G¼
- C** Female thread G¾
- D** Female thread G½
- E** Female thread G¾
- F** Female thread G1
- G** Female thread G1 ¼
- H** Female thread G1 ½
- J** Female thread G2

**⑧ Contacts (only with magnetic floats)**

- A** Without contact
- C** Contact K18/A (closes on falling below the limit)
- D** Contact K18/B (closes on exceeding the limit)
- E** 2 Contacts K18/A
- F** 2 Contacts K18/B
- G** One of each contact K18/A and K18/B

**⑨ Float version**

- 0** Standard
- 1** With magnet
- 2** Guided

**⑩ Other versions**

- B06** With calibration certificate
- Y01** Measured medium: always required, specify in plain text (Medium, Measuring range, Device range; Density; Viscosity, Operating temperature, Operating pressure)
- Y04** Silicone-free version
- Y99** Special version: specify in plain text

## 7 Measuring ranges for liquids

Standard Measuring range for liquids ( $\rho=1 \text{ kg/l}$ , Viscosity  $1 \text{ mPa}\cdot\text{s}$ )

Connection		Measuring cone	Dynamic	Maximum measuring range for the selected floats					Pressure loss float
PVC Adhesive bushing [mm]	Female thread			Stainless steel		PVC/PVDF	PVC/PVDF	Stainless steel	Stainless steel
					with magnet	weighted	with magnet weighted	viscosity	
				l/h	l/h	l/h	l/h	l/h	mbar
20	(G $\frac{1}{4}$ ), (G $\frac{3}{8}$ ), G $\frac{1}{2}$	C125	1:10	125	120	65	65	100*	11
		C315	1:10	315	300	175	175	240*	13
32	(G $\frac{1}{2}$ ), (G $\frac{3}{4}$ ), G1	D650 <sup>1)</sup>	1:10	TS 650	TS 600	TS 500	TS 450	TS 400*	17
		D650 <sup>2)</sup>	1:10	PS 600	PS 550	PS450	PS 400	PS 350*	17
		D1000	1:10	1000	950	750	700	600*	17
		D1600	1:10	1600	1500	1250	1100	1000*	20
		D2500	1:10	2500	2400	2000	1750	1400*	24
63	(G1), (G1 $\frac{1}{4}$ ), (G1 $\frac{1}{2}$ ), G2	E4000	1:10	4000*	3800*	3200	3200	2500*	25
		E6500	1:10	6500*	6400*	5000	5000	4000*	27
		F10000	1:10	10000*	9500*	7500	7500	5500*	32
		G16000	1:4	16000*	16000*	12500	12500	-	51
		H20000	1:3	20000*	19000*	-	-	-	65
		J25000	1:3	25000*	24000*	-	-	-	91

(Connections in brackets are not standard)

\*) guided float

- 1) Measuring cone made of Trogamid
- 2) Measuring cone made of Polysulfon

## 8 Measuring ranges for air

Standard Measuring range for air ( $p_{abs} = 1,013 \text{ bar}$ , at  $T=0 \text{ °C}$ ,  $\rho=1,293 \text{ kg/m}^3$ , viscosity  $0,0181 \text{ mPa}\cdot\text{s}$ )

Connection		Measuring cone	Dyna- mic	Maximum measuring range for the selected floats				Pressure loss float
PVC adhesive bushing [mm]	Female threads			Aluminium		PVC/PVDF		Aluminium
				l/h	with magnet l/h	not weighted l/h	weighted l/h	
20	(G $\frac{1}{4}$ ), (G $\frac{3}{8}$ ), G $\frac{1}{2}$	C125	1:10	2000	2500	1400	2200	4
		C315	1:10	5000	6400	3400	6000	5
32	(G $\frac{1}{2}$ ), (G $\frac{3}{4}$ ), G1	D650 <sup>1)</sup>	1:10	TS 10000	TS 12000	TS 7000	TS 10000	7
		D650 <sup>2)</sup>	1:10	PS9000	PS10500	PS 6500	PS 9000	7
		D1000	1:10	16000	20000	11000	16000	7
		D1600	1:10	28000	32000	18000	25000	7
		D2500	1:10	40000	50000	28000	40000	8
63	(G1), (G1 $\frac{1}{4}$ ), (G1 $\frac{1}{2}$ ), G2	E4000	1:10	64000*	75000*	45000	60000	9
		E6500	1:10	100000*	125000*	75000	100000	10
		F10000	1:10	160000*	180000*	120000	160000	13
		G16000	1:4	280000*	300000*	190000*	-	23
		H20000	1:3	350000*	400000*	240000*	-	31
		J25000	1:3	430000*	480000*	300000*	-	43

(connections in brackets are not standard)

\* guided float

<sup>1)</sup> Measuring cone made of Trogamid

<sup>2)</sup> Measuring cone made of Polysulfon

## 9 Technical Data

### Input

Flow	from the bottom to top upwards
Pressure limit	max. 10 bar

### Application conditions

#### Environmental conditions (temperature limits)

Measuring cone made of Trogamid	max. 60 °C (for water 50 °C)
Measuring cone made of Polysulfon	max. 90 °C
Pressure- & temperature limits	see table at chapter 9.1 (page 15)

#### Measuring accuracy

For liquids	G 2,5 qG 50% (acc. VDE/VDI 3513, sheet 2)
For air	G 2,5 qG 50% (acc. VDE/VDI 3513, sheet 2)

#### Measuring range

For liquids	6,5 l/h ... 25 m <sup>3</sup> /h
For gases	140 l/h ... 480 m <sup>3</sup> /h

#### Measuring units

Measuring cone D2500 and smaller	l/h
Measuring cone E4000 and larger	m <sup>3</sup> /h

#### Construction design

Measuring tube material	PVC-adhesive bushing, female thread, cast iron
Measuring cone material	Trogamid, Polysulfon
Connection (union nut)	PVC, cast iron
Connenction (inlay part)	PVC, cast iron, steel, stainless steel
Float	Stainless steel, Aluminium, PVC, PVDF
Float guide rod	Stainless steel (optionally for measuring cone C125 to D2500)
Gasket	NBR (NB2), FKM, EPDM
Stopper	Polysulfon

### 9.1 Pressure and temperature limits

T [°C]	Trogamid	Polysulfon
	P <sub>e</sub> [bar]	P <sub>e</sub> [bar]
-10 bis +60*	10,0	10,0
80	-	8,5
90	-	10,0

\* for water only up to +50°C

Connection parts PVC DIN 8062		
Medium	T [°C]	P <sub>e</sub> [bar]
For water and non-aggressive liquids	20	10,0
	40	10,0
	60	2,5
For aggressive media	20	10,0
	40	4,0
	60	1,0

$P_e$  = eff. pressure = overpressure



## 9.2 Dimensions

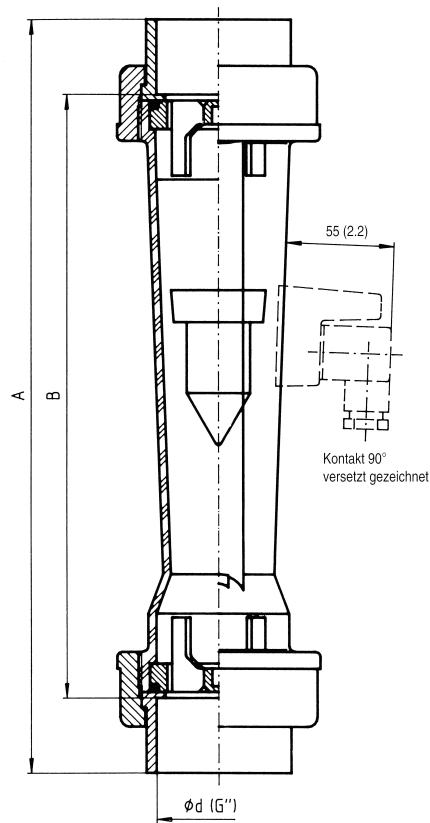

**Fig. 5** Troglux, Dimensions in mm

Connection		Dimension A [mm]			Dimension B [mm]	Weight [kg]
Adhesive bushing [mm]	Female thread	Adhesive bushing	Female thread			
			Cast iron	PVC/PVDF/ stainless steel	Adhesive bushing	
20	G½; NPT ½"	346 ± 4	350 ± 4	366 ± 4	306	0,4
32	G1; NPT 1"	356 ± 4	358 ± 4	358 ± 4	306	0,7
63	G2; NPT 2"	389 ± 4	379 ± 4	366 ± 4	306	2,2

## 9.3 Float selection

There are three versions of floats available:

- Float non guided (A)
- Float guided (B)
- Float for stable viscosity (C)

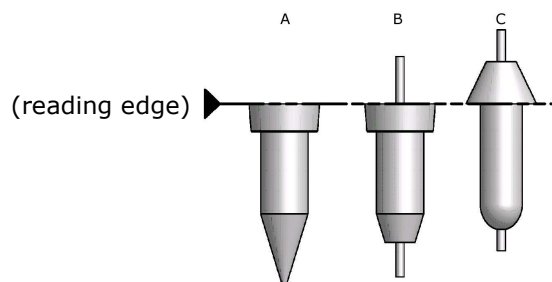

**Fig. 6** Versions of float

## 10 Contacts

The bistable contact K18 is intended for signaling of limit values and for controlling purposes.

### Special features

- bistable function
- high vibration resistance
- no interaction between contacts
- low cost plastic version
- easy to use electrical connection

### Mode of operation

A bistable reed contact consists of a spring contact which is covered by a glass tube filled with inert gas. It is operated by a magnetic field. This magnetic field is generated by a permanent magnet inside the float of a MECON flowmeter.

There are two versions available:

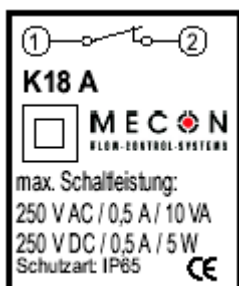

**Fig. 7** Contact K 18 A

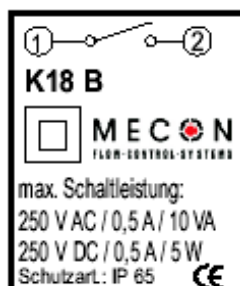

**Fig. 8** Contact K 18 B

**K 18 A:** contact closes on falling below the limit

**K 18 B:** contact closes on exceeding the limit

### Electrical loadability

The spring contacts of the K18 are sensitive to current overload (max. 500 mA). A high current could lead to a welding effect and this will damage the contact blades – this specifically applies to inductive loads e.g. relays (high self-induction).

### Protective circuits

At great cable lengths (cable capacity) it is recommended to connect a protective resistor in series to contact K18 A(B) for current limitation.

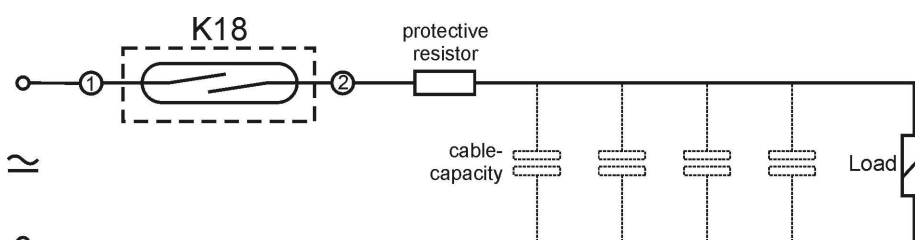

**Fig. 9** Protective circuit for current limitation

When using a DC power supply in combination with an inductive load it is recommended to connect a diode in parallel to the load.

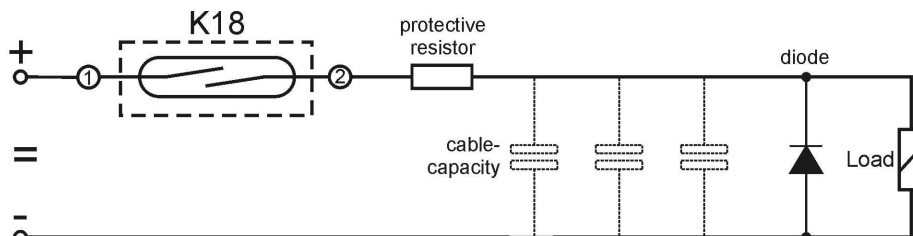

**Fig. 10** Protective circuit for inductive loads and DC power supply

### Technical data

Contact material	Rhodium (with inert gas)
max. switching capacity	5 W / 10 VA
Max. switching voltage	250 V DC/AC
Contact resistance	0,1 $\Omega$
Isolation resistance	$10^{11}$ $\Omega$
Contact closing time	2 ms
Contact opening time	0,07 ms
Frequency of operation	2000 Hz
Duration of bounce	0,5 ms
Temperature range	-40 °C to +80 °C
Material of housing	Plastics
Electrical connection	Rectangular connector acc. to DIN EN 175301-803 (previously DIN 43 650)
Protection class	IP 65
Max. starting current (peek)	0,5 A
Max. switching current	230 V DC : 21 mA 115 V DC : 43 mA 24 V DC : 0,2 A 10 V DC : 0,5 A



### **Warning !**

Observe in any case the max. switching capacity and the max. starting current – otherwise a welding effect will damage the contact blades.

**Installation of the connection cable to the connector:**

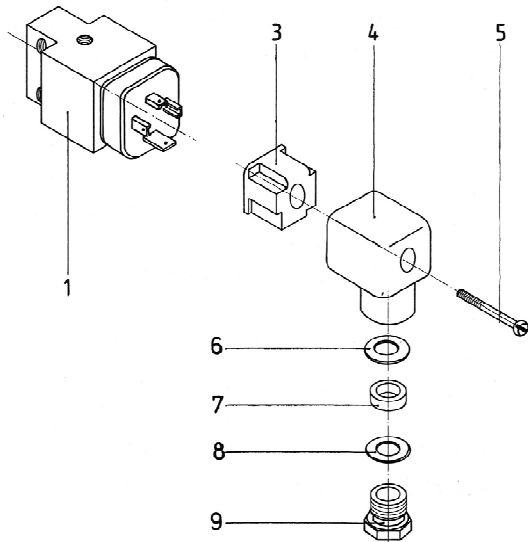

1. Remove the cable gland (9) and take out the gasket kit (8, 7, 6).
2. Remove the locking screw (5) and pull of the housing (4) from the insert connector (3).
3. Insert the connection cable through the cable gland (9), the gasket kit (6, 7, 8) and the housing.
4. Connect the wires to terminal 1 and 2 of the insert connector.
5. Assemble the rectangular connector in reverse order as described above. Please note, that the cable outlet can be varied by rotating the insert connector (4) through 90°.

**Fig. 11** Explosion drawing contact K 18

**Commissioning:**

When commissioning the contact K18 we recommend to ensure the correct position of the bistable contact by moving the float along the K18 in flow direction.

**MECON GmbH**

Röntgenstr. 105  
D-50169 Kerpen / Germany

Phone: +49 (0)2237 600 06 - 0  
Fax: +49 (0)2237 600 06 - 40  
Email: [customerservice@mecon.de](mailto:customerservice@mecon.de)

[www.mecon.de](http://www.mecon.de)

